

TOSHIBA

Carrier

REMOTE CONTROLLER FOR AIR CONDITIONER (SPLIT TYPE)

Installation Manual

Remote Controller

Model name:

Wireless remote controller kit

TCB-AX21UL

Generic model name	Wireless remote controller and Signal receiving unit
TCB-AX21UL	WX-TA01UES (Wireless remote controller model name)

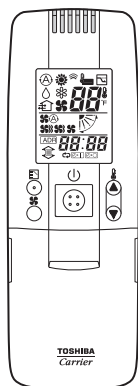

**Wireless remote controller
(WX-TA01UES)**

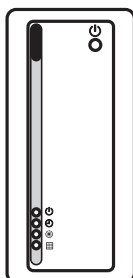

**Signal receiving
unit**

Installation Manual
Remote controller for air
conditioner (Split type)

1

English

Manuel du propriétaire
Télécommande pour climatiseur
(Type split)

15

Français

Thank you very much for purchasing TOSHIBA/Carrier Remote Controller for Air Conditioner.

Please read the owner's manual carefully before using your Remote Controller for Air Conditioner.

- Be sure to obtain the "Owner's manual" and "Installation manual" from constructor (or dealer).













Request to constructor or dealer

- Please clearly explain the contents of the Owner's manual and hand over it.

Contents

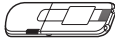
1	ACCESSORY PARTS	2
2	SWITCH LOCATION OF SIGNAL RECEIVING UNIT	3
3	INSTALLATION LOCATION OF SIGNAL RECEIVING UNIT	4
4	HOW TO INSTALL THE SIGNAL RECEIVING UNIT	5
5	HOW TO PERFORM CABLING OF THE SIGNAL RECEIVING UNIT ...	8
6	REQUIREMENT	9
7	HOW TO SET THE ROOM TEMPERATURE SENSOR	10
8	HOW TO SET THE ADDRESS SWITCH	11
9	SLIDE SWITCH	11
10	SELF-DIAGNOSIS TABLE AND MEASURES	12
11	CAUTIONS FOR INSTALLATION OF THE REMOTE CONTROLLER ..	12
12	EXPLANATION TO CUSTOMERS	13
13	HOW TO HANDLE THE REMOTE CONTROLLER	13
14	TEST RUN	14

1 ACCESSORY PARTS

No.	Parts		Quantity
1	Signal receiving unit (provided 7.9" (200 mm) power cable)		1
2	Mounting bracket		1
3	Screws $\varnothing 0.16"$ x 1.0" (M4 x 25 mm)		2
4	Screws $\varnothing 0.16"$ x 1.6" (M4 x 40 mm)		2
5	Wood screws		2
6	Spacer		4
7	Wire joints		2
8	Cable tie		1
9	Pattern template 3.7" x 2" (95 mm x 51 mm)		1
10	Remote controller		1
11	Remote cotroller holder		1
12	Truss tapping screw, $\varnothing 0.16"$ x 0.63" (M4 x 16 mm)		2
13	Installation manual		1
14	Owner's manual		1

2 SWITCH LOCATION OF SIGNAL RECEIVING UNIT

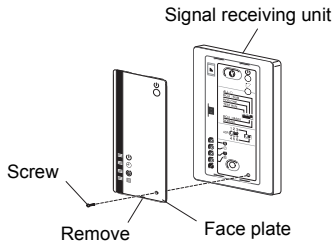

Remove the face plate from Signal receiving unit.

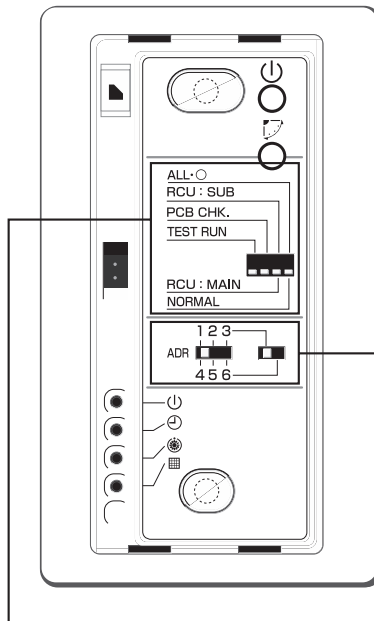

Address selector switch

This switch is used to address one of a maximum of six air conditioners that can be controlled by the remote controller. (Refer to page 11.)

All·O/NORMAL selector switch

Set this switch to the "NORMAL" position for the normal operation of the air conditioner. When this switch is set to the "All·O" position, the indoor unit of the air conditioner is turned off.

RCU:SUB/RCU:MAIN selector switch

Set this switch to the "RCU:MAIN" position for normal operation. Refer to page 9 for setting to the "RCU:SUB" position.

PCB CHK switch

This switch is not used and should be set in the position shown in the figure.

TEST RUN switch

This switch is used for test running.

3 INSTALLATION LOCATION OF SIGNAL RECEIVING UNIT

- Do not install in a location where the air contains oil mist, such as in a kitchen or factory.
- Do not install next to a window, or in any other location directly exposed to sunlight and outside air.
- Do not install nearby devices which can be expected to produce electrical noise, such as elevators, automatic doors, and industrial sewing machines.
- If the Signal receiving unit is installed near a rapid-start type or inverter-type fluorescent lamp (a lamp which does not include a glow lamp), it may not be possible to receive the wireless remote controller signal in some cases. In order to prevent interference from fluorescent lamps, leave a minimum of 6'7" (2 m) between the Signal receiving unit and the fluorescent lamps, and install the Signal receiving unit in a location where it can receive the wireless remote controller signal when the fluorescent lamps are lit.

4 HOW TO INSTALL THE SIGNAL RECEIVING UNIT

NOTE

- To avoid malfunction of the remote controller, do not assemble or run remote control wiring together with the power cables, and do not enclose them in the same metal conduit.
- When the power unit induces electrical noise, it is recommended that a noise filter or the like be installed.

For flush mounting into a wall, install the Signal receiving unit in a metal switch box (field supply) that has been recessed into the wall in advance.

1. Insert a flathead screwdriver or similar tool into the notch, and remove the face plate.
2. Fix the Signal receiving unit with 2 $\varnothing 0.16''$ (4 mm) screws provided. Do not overly tighten, and use the provided spacers. If the Signal receiving unit does not fit in the wall, cut spacers to adjust the clearance.
3. Connect the Signal receiving unit wiring (2-core cable) with the cables extended from the indoor unit.

(Refer to the section on Signal receiving unit wiring.)

Be sure to determine the correct terminal numbers on the indoor unit when wiring the Signal receiving unit. The remote controller will be damaged if high voltage (such as 208/230 VAC) is applied.

4. Reattach the face plate.

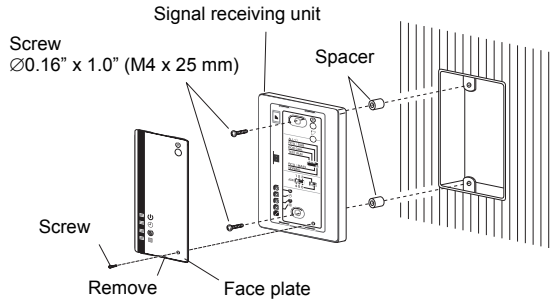

When using exposed mounting for the Signal receiving unit, install onto a wall where the Signal receiving unit can be attached.

1. Insert a straight blade screwdriver or similar tool into the groove on the bottom of the Signal receiving unit. Pry open with the screwdriver and remove the lower case. (Fig. A).

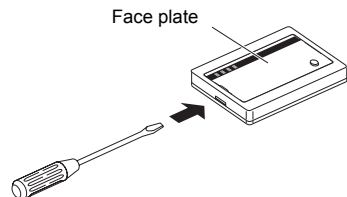

Fig.A

- In order to later pass the Signal receiving unit wiring out through the upper case (thin part at the top center), use nippers or a similar tool to cut a notch in the same size as the Signal receiving unit cord (optional). (Fig. B)

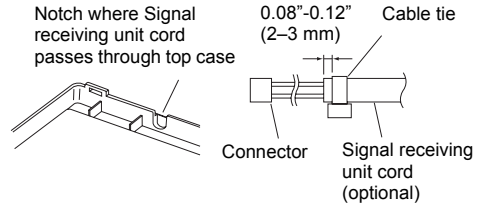

Fig.B

- Disconnect the wires that were connected to the connector at the time of shipment.
- Fasten the Signal receiving unit cord (optional) at the position shown in Fig. C, using the provided cable tie. Then connect the cord to the Signal receiving unit connector.
- Shape the Signal receiving unit cord as shown in Fig. C so that it fits at the top inside the Signal receiving unit, above the PCB. Then attach the lower case. At this time, bend the head of the cable tie so that it faces sideways.

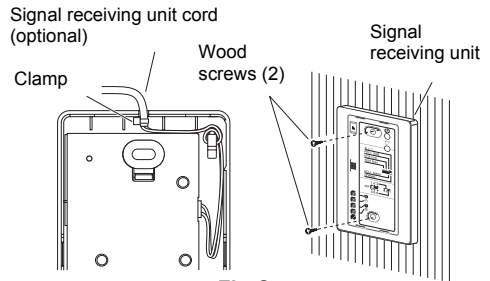

Fig.C

- Remove the nameplate and use 2 wood screws to attach the Signal receiving unit.
- Use the provided cord clips to fasten the Signal receiving unit cord to the wall.
- Reattach the face plate.

If the separate Signal receiving unit is installed on the ceiling, use the provided ceiling mounting bracket for installation.

- Insert a screwdriver or similar tool into the notch at the bottom to remove the Signal receiving unit face plate.
- Cut a section out of the ceiling along the provided paper pattern (3.7" x 2" (95 x 51 mm)).
- Pass the wire through the provided mounting bracket and insert the bracket into the installation hole. (Fig. D)

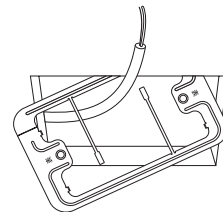

Fig.D

4. Use bracket parts (A) and (B) to securely grip the ceiling material. (Fig. E)
5. Connect the Signal receiving unit wire (2-core) to the wire from the indoor unit. (Refer to "Wiring the Signal receiving unit.") Check the terminal number on the indoor unit before wiring the Signal receiving unit and be sure not to wire incorrectly. (The unit will be damaged if high voltage, such as 208/230 VAC, is applied.)
6. Adjust the provided spacers so that they are several millimeters larger than the thickness of the ceiling material. Pass the 2 supplied screws (0.16" x 1.6" (M4 x 40 mm)) through the spacers and tighten them enough to hold the Signal receiving unit in place.

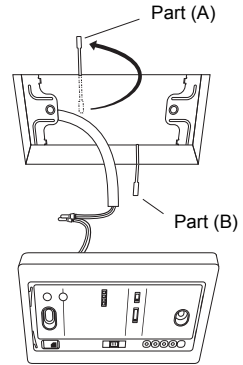

Fig.E

7. Return parts (A) and (B) through the gap between the ceiling and Signal receiving unit so that they are contained in the openings. Then tighten the screws. Do not tighten the screws excessively. This may result in damage or deformation of the case. Tighten to the point where the Signal receiving unit can be moved slightly by hand. (Fig. F)

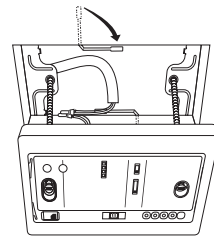

Fig.F

8. Reattach the face plate.

5 HOW TO PERFORM CABLING OF THE SIGNAL RECEIVING UNIT

■ Flush Mounting

Connection diagram

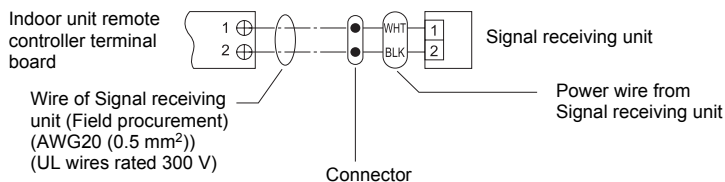

Provided wire joint (WHT 2)

1. Strip the insulation to approximately 0.55" (14 mm) from the ends of the wires to be connected.
2. Twist together the 2 wires and create a crimp connection at the wire joint.
3. If a special crimping tool is not used, or if the connection is soldered, insulate the wires using insulation tape.

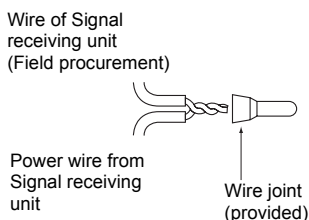

■ Exposed Mounting

• Connection diagram

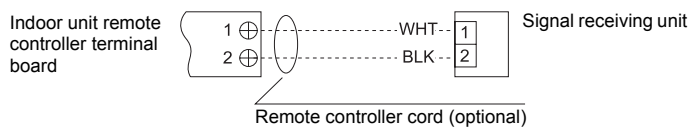

6 REQUIREMENT

The control by two remote controllers is enabled by installing the wireless remote controller with the wired remote controller for an indoor unit.

(Max. 2 remote controllers of wireless or wired are insatiable.)

“2-remote controllers” controlling means that one or multiple units are operated by the multiple remote controllers.

NOTE

1. Upon confirmation of the terminal numbers of the indoor unit, connect the remote controller cables without miscabling. (If applied AC 208/230 Volt, damage the unit.)
2. The multiple wireless remote controller kits cannot concurrently be used for an indoor unit.
3. When installing simultaneously the wireless remote controller with the wired remote controller, set one of them as the sub remote controller.
 - When setting the wired remote controller as the sub, exchange the address connector at the rear of P.C. board of wired remote controller from master to sub remote controller.
 - When setting the wireless remote controller as the sub, turn the switch of wireless remote controller Signal receiving unit from RCU: MAIN to RCU:SUB.

To operate an indoor unit by 2 remote controllers

The indoor unit is operated if either wireless or wired remote controller is set as MAIN or SUB remote controller.

(Total cable length: Within 1312'4" (400 m))

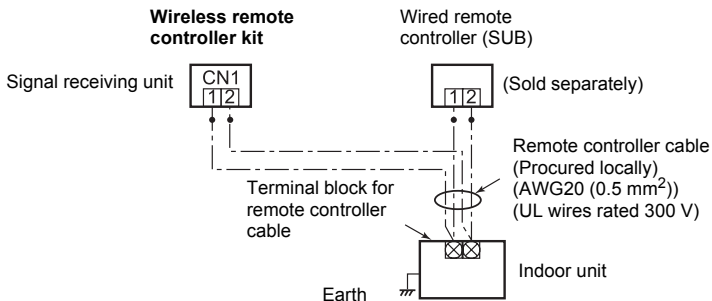

To operate a group control of multiple indoor units by 2 remote controllers

MAIN and SUB remote controllers are operable even if they are installed to any indoor unit.
(Total cable length: Within 656'2" (200 m))

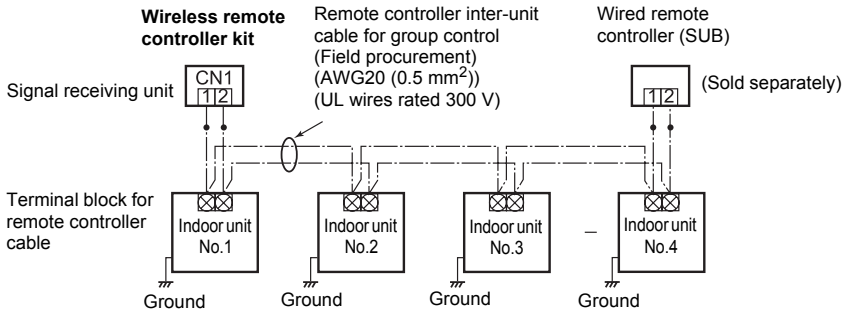

7 HOW TO SET THE ROOM TEMPERATURE SENSOR

- The room temperature sensors are equipped in the indoor unit and the wireless remote controller.
One of two sensors works.
- The room temperature sensor is set to the indoor unit side as factory default.
To select the sensor in the remote controller, push the **SENSOR** button (figure below) inside of the remote controller cover and check “” disappears from LCD.

NOTE

If the room temperature data from the remote controller is not transmitted to the unit for 10 minutes or more, the sensor at indoor unit side is automatically selected even if the sensor at the remote controller side is selected.

Fix the remote controller toward the unit as possible.

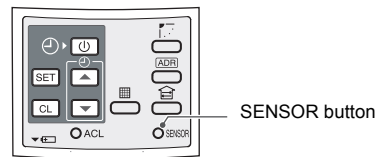

8 HOW TO SET THE ADDRESS SWITCH

- When the multiple Signal receiving units are installed in the same room, an address can be set to prevent cross communication.
- When replacing the battery and pushing ACL button, the address of the remote controller becomes [ALL] and the Signal receiving unit is enabled to receive signal regardless of setting of address switch of the operation section.
- For selecting of the remote controller address, refer to Owner's Manual.
- Change the address of the Signal receiving unit by removing screws of P.C. board cover of the Signal receiving unit. After then, fix the cover with screws using a clamp.

Display of remote controller address	Address ALL	Address 1	Address 2	-----	Address 6
Address switch position of Signal receiving unit	Address switch of Signal receiving unit can be set any position.			-----	

The address switch is inside the cover of Signal receiving unit.

Contact the dealer for setting of the switch.

Turn the Ⓐ switch to left for 1, 2 and 3, and right for 4, 5 and 6.

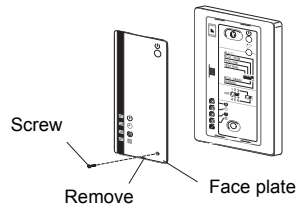

9 SLIDE SWITCH



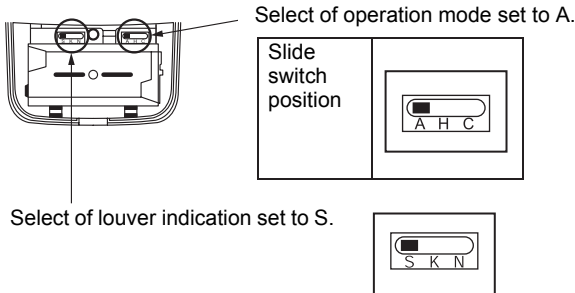

- Check the slide switch in the battery box of the remote controller is set to [S] / [A] as factory default.



10 SELF-DIAGNOSIS TABLE AND MEASURES

Lamp indication of Signal receiving unit

- : Goes off
- ☀ : Blink
(0.5-sec. interval)

Lamp indication	Cause	Measures
 No indication even if the remote controller is operated.	Power supply is not turned on. Miscabling between Signal receiving unit and indoor unit	Check cable connection and correct it.
	Defective connection between Signal receiving unit and indoor unit	
	Miscabling or defective connection between indoor and outdoor units.	
 Blinks alternatively	Protective device of outdoor unit works.	Check outdoor unit.
 Blinks alternatively	Protective device of indoor unit works.	Check indoor unit.

11 CAUTIONS FOR INSTALLATION OF THE REMOTE CONTROLLER

- To operate the remote controller by fixing it to the wall, etc. with a remote controller holder, turn on the fluorescent lamp, operate the remote controller at the position to be fixed, check the air conditioner normally operates, and then mount it.
- When the room temperature is sensed by the remote controller, mount the remote controller paying attention to the following items.
 - Place not exposed directly to cold or hot wind.
 - Place not exposed directly to the sunlight.
 - Other places where the remote controller is not influenced.

12 EXPLANATION TO CUSTOMERS

- Hand over the “Owner’s Manual” and “Installation Manuals” to the customer after installation works.
- Explain usage and maintenance of the remote controller according to “Owner’s Manual”.

13 HOW TO HANDLE THE REMOTE CONTROLLER

In case using remote controller mounting to the wall, etc.

Check a signal is received correctly by pushing (⏏) button at the position to be fixed.

Mounting screw Truss tapping
 Ø0.16" x 0.63" (M4 x 16mm)

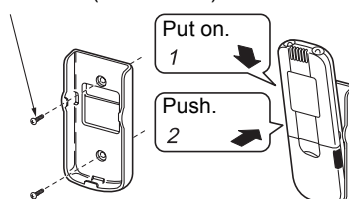

- To take off remote controller, pull it toward you.

Replacement of battery

1. Holding the both ends of the cover and remove it by sliding downward.
2. Correctly insert 2 AAA alkali batteries matching (+) and (-) polarities with indications.
3. Push ACL button with something tipped and attach the cover.

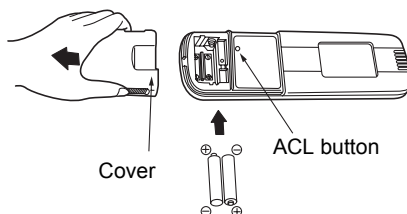



14 TEST RUN

Before test run

- Before turning on the power supply switch, carry out the following procedure.
 - 1 Using 500V-megger, check $1M\Omega$ or more exists between the terminal block 1 to 3 and the earth. If $1M\Omega$ or less is detected, do not run the unit. Do not apply to the remote controller circuit.
 - 2 Check the valve of the outdoor unit being opened fully.
- To protect the compressor at activation time, leave power-ON for 12 hours or more before operating.

How to conduct a TEST RUN

1. Remove the face plate from the Signal receiving unit.
Set the "TEST RUN" switch to the "TEST RUN" position.
2. Push the button on the wireless remote controller to start the operation of the air conditioner.
The , , and  lamps each light under test running.
The temperature cannot be set by the wireless remote controller with the "TEST RUN" switch is set to the "TEST RUN" position.
3. Operate the air conditioner in the "heating", "cooling", or "fan only" mode during test running.
The outdoor unit will not operate for approximately 3 minutes after the air conditioner has been turned on or off.

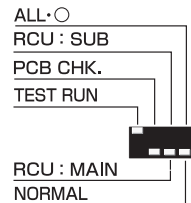

CAUTION

Do not set the switch to the "TEST RUN" position other than for test running.
The air conditioner may be damaged if this switch is set to the "TEST RUN" position for normal operation.
(The Signal receiving unit automatically turns off the air conditioner 60 minutes after the switch has been set to the "TEST RUN" position to prevent continuous test running.)

TOSHIBA CARRIER CORPORATION

85464369216000
(EH99677601)